



FUTURE-PROOFING THE WORLD OF **DRY BULK** SOLIDS HANDLING

TABLE OF CONTENTS

WHY DMN-WESTINGHOUSE	02	ROTARY VALVE SOLUTIONS	54
ABOUT DMN-WESTINGHOUSE	04	SAS-II	55
DMN-WESTINGHOUSE PRODUCTS	22	RID 3.0	56
HEAVY-DUTY ROTARY VALVES	26	Shaft seal flow control	58
DROP-THROUGH		ROTARY VALVE ACCESSORIES	60
Multipurpose AL/AXL Round flanges	30	Inlet restrictor	60
AML Round & square flanges	32	Drop-out box	61
USAL Square flanges	34	Vent box	61
Granular GL Round flanges	35	Cradle for MZC-I and MZC-II	61
Replacement NR	36	Bearing toolkit	61
Sanitary SAL	37	DIVERTER VALVES	62
BLOW-THROUGH		Plug type PTD-II	64
BL/BXL/BXXL Round flanges	38	SPTD & SPTDS	66
OPTIONAL SLIDE RAILS		GPD	68
MZC-I & MZC-II (GL, SAL and USAL excluded)	40	Tube type 2-TDV & 3-TDV	70
MEDIUM-DUTY ROTARY VALVES	42	M-TDV	72
DROP-THROUGH		Flap type FDV-P & FDV-F	74
Multipurpose MLD Round & square flanges	44	Ball type BTD	75
MALD Round flanges	44	COMPONENTS	76
Dust valve DL Universal flanges	46	Pressure relief valve (PRV)	76
ROTARY VALVE OPTIONS	48	Compression couplings	76
Rotor configurations	48	Discharge unit (DUC)	77
Coating options	50	CONTACT	79
Drive options	52		

OPTIMISE YOUR FLOW

When dry bulk handling is part of your industrial process, DMN-WESTINGHOUSE is the partner offering you efficient and affordable solutions. Whether you are in dairy, plastics, aquaculture, chemicals, or any other industry handling dry bulk, we specialise in implementing future-proof solutions that enhance the efficiency of your dry bulk flow.

FUTURE-PROOF QUALITY

What are your biggest challenges concerning international rules and regulations? How can you maximise the uptime of your conveying processes? How can you increase product quality while decreasing costs for maintenance and repairs? With decades of experience designing and manufacturing high-end rotary valves and diverter valves, we know exactly what you need. Today and in the future.

RELIABLE PARTNERS WORLDWIDE

No matter your inquiry or the challenges you face in dry bulk handling, our extensive network of sales offices and distributors guarantees local and timely support. Our specialists are on hand to assist you in selecting the most suitable solution for your unique requirements. Beyond the initial setup, we remain committed to the efficiency of your operations by offering comprehensive operator training and a robust approach to spare parts and maintenance.



“Our engineering and support teams are always nearby”

“We help you comply with the rules and regulations regarding hygiene, safety, and durability”

FUTURE-PROOFING THE WORLD OF DRY BULK SOLIDS HANDLING

At DMN-WESTINGHOUSE, we are all about process continuity, not only regarding your dry bulk handling processes, but also when it concerns our own company. That's why we have never strayed from designing, manufacturing, and innovating rotary valves and diverter valves. This hyperfocus has made us the leading brand worldwide.

On the basis of our extensive experience, we offer tailored solutions and solid support to customers worldwide. By pushing the boundaries of technical engineering and rotary valve and diverter valve design, we help you comply with the rules and regulations regarding hygiene, safety, and durability.

Our focus on high-end quality, innovation, and reliability has led to our valves being qualified, certified, and verified to the highest standards. We call that future-proof value because we are always a step ahead for your benefit and that of ourselves.

DMN-WESTINGHOUSE: FUTURE-PROOF VALUE SINCE 1950

OUR VALUES

WE ARE DEDICATED

Every day, we push the boundaries of technical engineering and the design of our rotary valves and diverter valves to find future-proof solutions that help our customers surpass themselves and their competitors. We take pride in our skills and work meticulously to get things right. We aim to make a difference and deliver the high-end quality our customers rely on.

WE ARE RELIABLE

We are a dependable business partner, always ready to help, always there to act, and consistently delivering on our promise. We are open and honest with each other and our customers. We demonstrate this in our communications, in our work, and in how we operate. We trust and inspire each other to fulfil our mission together. We help each other when faced with difficulties.

WE ARE PROACTIVE

At DMN-WESTINGHOUSE, we don't wait for the future; we are proactive. We constantly look for ways to improve our products and services to benefit our customers. We take all their questions and concerns about developments in their business seriously. We are a learning organisation; we are flexible and quick to adapt.

WE ARE RESPONSIBLE

We care for our environment and the world we are part of. We do everything we can to minimise waste and use our resources as economically and sustainably as possible. We respect others and treat other people as we would like to be treated. We are an inclusive employer, and we embrace diversity in our workforce. We take responsibility for a safe and healthy workplace and for our colleagues' well-being.

SUSTAINABILITY AT OUR CORE

At DMN-WESTINGHOUSE, we're at the forefront of sustainable innovation for the dry bulk handling industry. Our mission is to provide enduring, future-proof solutions that go beyond short-term gains. We focus on eco-friendly, efficient, durable designs while reducing waste and energy use to meet our customers' sustainability goals and boost their profitability.

Our global commitment to sustainability is manifested through our alignment with the United Nations Sustainability Goals (SDGs)

and our EcoVadis certification. We prioritise environmental care, waste reduction, and efficient use of resources. Our inclusive, respectful workplace culture ensures a safe, healthy environment for our diverse team.

Beyond our economic goals, we strive to make a positive impact. We integrate sustainability in our business model, aiming to contribute significantly to a better, more sustainable world. This drives us to create solutions that benefit our planet and our customers.

“Future-proof solutions
that go beyond
short-term gains”

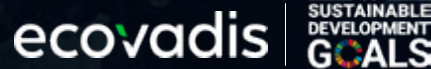

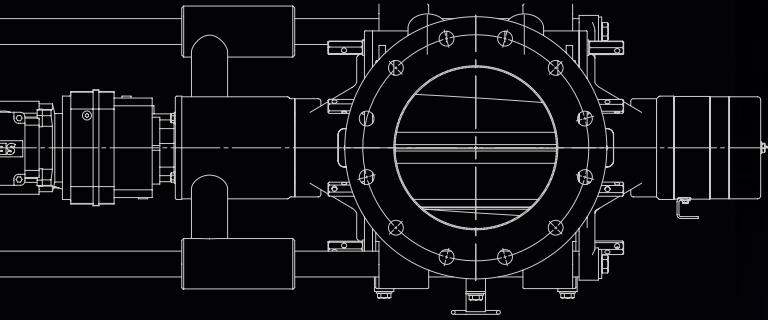

ENGINEERING EXCELLENCE

At DMN-WESTINGHOUSE, our engineers have the necessary expertise to design rotary and diverter valves for bulk handling, and they create solutions that meet customer requirements while adhering to safety, reliability, efficiency, and industry standards.

The R&D department has a proactive and ambitious approach, aiming to be at the forefront of technological advancements while keeping a keen eye on customer needs. This combination of innovation, technology, and customer focus is key to staying competitive and successful in today's dynamic business environment. Product development and testing happens in collaboration with partners that are leading companies in product and material handling.

“With an endless drive for innovation, their goal is always to stay ahead”



QUALIFIED, VERIFIED, CERTIFIED!

DMN-WESTINGHOUSE has the knowledge, skills, and experience to provide the configured solutions you need. We will, therefore, continue to ensure our products are qualified, verified, and certified to the highest standards.

DMN-WESTINGHOUSE's rotary valves and diverter valves are renowned for their reliability and durability, earned through continuous innovation and improvement. Driven by industry feedback, we focus on safety, efficiency, ease of cleaning, and reliability. Our products' certifications reflect our commitment to delivering exceptional value. Today and in the future.

BUILT TO SERVE YOUR PURPOSE

HYGIENIC

In certain industries that handle dry bulk, like food or pharma, hygienic production is not just a standard, but a necessity. Adherence to stringent hygiene protocols ensures product purity and safety, protecting against contamination risks. This commitment to cleanliness is fundamental in delivering quality and maintaining consumer trust.

DMN-WESTINGHOUSE has developed hygienic heavy-duty rotary valves and diverter valves that ensure product safety by design. These rotary valves and diverter valves are certified to comply with USDA, EHEDG and 3-A sanitary standards. They facilitate quick and easy cleaning, cutting downtime, and boosting productivity.

EXPLOSION-PROOF

In the dry bulk industry, the risk of explosions poses a significant challenge, demanding constant vigilance. At DMN-WESTINGHOUSE, we understand these hazards and emphasise the critical importance of explosion-proof solutions. Our advanced safety measures are designed to mitigate risks, ensuring a secure environment for dry bulk processing. This commitment to safety protects both the integrity of operations and the well-being of personnel.

We manufacture rotary valves and diverter valves with ATEX and NFPA69 certification for industrial environments with a high risk of explosions. ATEX, derived from the French “ATmosphères EXplosibles”, sets essential standards for equipment used in explosive atmospheres. For industry professionals, compliance with ATEX is not just a regulatory requirement; it’s a commitment to operational safety and reliability. For the United Kingdom, we support the UKEX certification.

HIGH-QUALITY PRODUCTS FOR VARIOUS INDUSTRIES

DMN-WESTINGHOUSE excels in delivering customised dry bulk handling solutions across a spectrum of industries, from agriculture to energy and pharmaceuticals to construction. Our expertise lies in tailoring each solution to meet the distinct needs of every sector, ensuring efficient and reliable handling of materials, whether it's grain, highly abrasive minerals, pharmaceutical granules, or construction aggregates. Our commitment to quality, reliability, and customisation positions us as the leading global provider of industry-specific bulk-handling equipment.

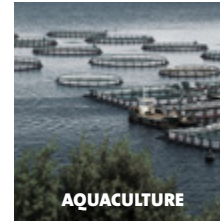

AQUACULTURE

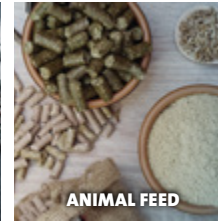

ANIMAL FEED



(EV) BATTERIES

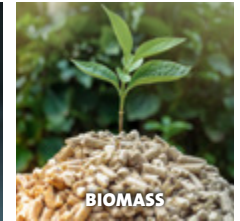

BIOMASS

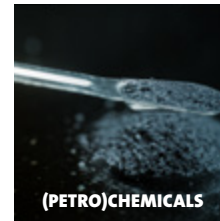

(PETRO)CHEMICALS

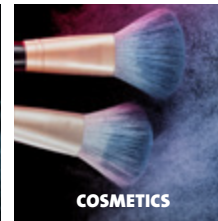

COSMETICS

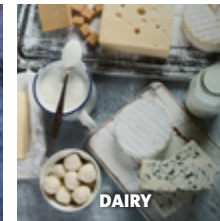

DAIRY



FOOD



INFANT FORMULA



MINERALS

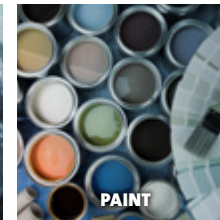

PAINT

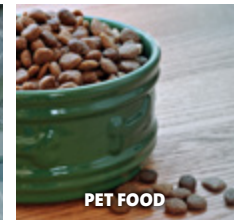

PET FOOD



PHARMA

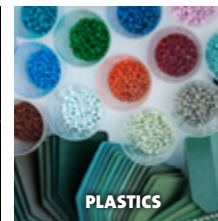

PLASTICS

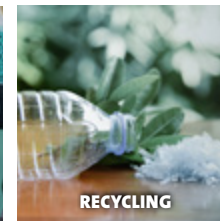

RECYCLING

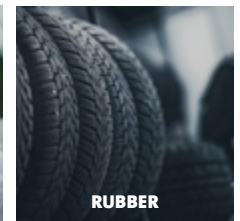

RUBBER

INDUSTRY-SPECIFIC APPLICATIONS FOR OUR PRODUCTS

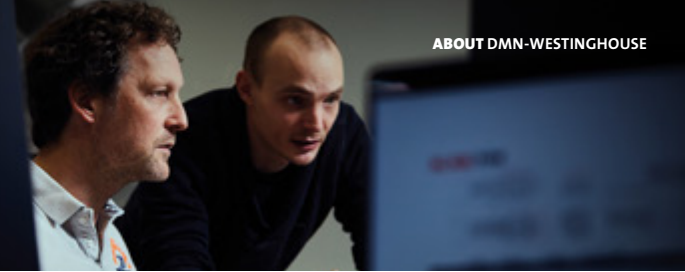

ROTARY VALVES

TYPE	HEAVY-DUTY									MEDIUM-DUTY		
	DROP-THROUGH					BLOW-THROUGH	OPTIONAL SLIDE RAILS			MLD	MALD	DL
	AL/AXL	AML	USAL	GL	NR	SAL	BL/BXL/BXXL	MZC/MZC-I	MZC-II			
Aquaculture	✓	✓	✓				✓	✓	✓			✓
Animal feed	✓	✓	✓	✓			✓	✓	✓	✓	✓	✓
(EV) Batteries	✓	✓	✓				✓					✓
Biomass	✓	✓	✓				✓					✓
(Petro)chemicals	✓	✓	✓		✓	✓	✓	✓		✓	✓	
Cosmetics	✓	✓	✓		✓	✓	✓	✓		✓	✓	✓
Dairy	✓	✓			✓		✓	✓				✓
Food	✓	✓	✓		✓		✓	✓	✓	✓	✓	✓
Infant formula	✓	✓			✓		✓	✓				✓
Minerals	✓	✓	✓				✓			✓	✓	
Paint	✓	✓	✓				✓	✓	✓	✓	✓	✓
Pet food	✓	✓	✓				✓	✓	✓	✓	✓	✓
Pharma	✓	✓			✓	✓	✓	✓				✓
Plastics	✓	✓	✓	✓			✓			✓	✓	✓
Recycling	✓	✓	✓				✓			✓	✓	✓
Rubber	✓	✓	✓				✓					

DIVERTER VALVES

TYPE	PLUG TYPE				TUBE TYPE			FLAP TYPE		BALL TYPE
	PTD-II	SPTD	SPTDS	GPD	2-TDV	3-TDV	M-TDV	FDVP	FDVF	BTD
Aquaculture	✓			✓	✓	✓	✓			
Animal feed	✓	✓	✓	✓					✓	
(EV) Batteries	✓	✓	✓	✓				✓	✓	✓
Biomass	✓	✓	✓	✓				✓	✓	✓
(Petro)chemicals	✓	✓	✓	✓	✓	✓	✓		✓	
Cosmetics	✓	✓	✓	✓	✓	✓	✓		✓	
Dairy	✓			✓	✓	✓	✓			
Food	✓	✓	✓	✓	✓	✓	✓		✓	
Infant formula				✓	✓	✓	✓		✓	
Minerals	✓	✓	✓	✓				✓	✓	✓
Paint	✓	✓	✓	✓			✓	✓	✓	✓
Pet food	✓	✓	✓	✓	✓	✓	✓			
Pharma	✓		✓	✓	✓	✓	✓			
Plastics	✓	✓	✓	✓				✓	✓	✓
Recycling	✓	✓	✓	✓				✓	✓	✓
Rubber	✓	✓	✓	✓				✓	✓	✓

FIRST-CLASS SUPPORT

Our commitment extends beyond engineering excellence; we empower your company with comprehensive operational training and preventive maintenance. Our global network of distributors and sales offices ensures local, timely support and a seamless service experience, keeping your operations uninterrupted and efficient.

As more than just a supplier, DMN-WESTINGHOUSE is a dedicated partner in your success, with our after-sales department playing a pivotal role in helping you achieve operational excellence.

AFTER-SALES DEPARTMENT

To ensure optimal performance and durability of your DMN-WESTINGHOUSE products and components, we proactively assist you in managing wear and tear. Worn-out parts can result in downtime, dust, and potential damage. Our global after-sales department is the core of every service you could need after purchasing DMN-WESTINGHOUSE products, from spare parts and refurbishment to training your service engineers and handling warranties. If you need guidance on replacing worn parts or optimising your spare part usage, contact your DMN-WESTINGHOUSE office or authorised distributor for expert assistance.

WE ARE HERE TO SUPPORT YOU WITH:

General service, spare parts, training of service engineers and authorised service partners, (re)certifications, refurbishment, and warranty handling.

A man with a shaved head and blue eyes, wearing a blue t-shirt and earbuds, is focused on his work. He is holding a metal tool, possibly a screwdriver, and is looking intently at a piece of machinery in the foreground. The background is a blurred industrial setting with various mechanical parts and equipment.

“Our after-sales department is the core of every service you could need after purchasing our products”



THE IMPORTANCE OF CHOOSING THE RIGHT SOLUTION

Selecting the appropriate rotary valve or diverter valve is crucial, particularly considering the material type and system configuration. This is important for managing material flow and ensuring safety, particularly for combustible materials. A diverter valve is ideal for redirecting material flow, while a rotary valve is specifically engineered for metering and precise flow control.

Also, different materials require different housing and configurations. To assist you

in selecting the most suitable rotary valve or diverter valve, we have organised our rotary valves into heavy- and medium-duty categories, offering drop-through and blow-through types. Our diverter valves also offer a range of diverse types and configurations that can be tailored to your specific needs.

Diverter valves are categorised into various types based on operating principles and design, such as plug, tube, flap, or ball types.

HEAVY- AND MEDIUM-DUTY

The heavy-duty category is for crucial conveying procedures with minimum air leakage and high filling efficiency. The medium-duty category is designed for general-purpose applications where simple construction and direct drive provide exceptional value for money.

DROP- AND BLOW-THROUGH

Drop-through rotary valves manage material flow from the inlet to the outlet. They excel in gravity and pressure scenarios, feeding various types of downstream equipment. They can feed a pneumatic conveying line when equipped with a drop-out box. Drop-through rotary valves are ideal for multiple valve systems with a design that ensures product integrity.

Blow-through rotary valves handle cohesive materials like cocoa, flour, or milk powders. Their unique design integrates seamlessly with pneumatic convey lines, efficiently clearing sticky substances from rotor pockets. While too compact and unsuited for highly abrasive materials, a blow-through rotary valve is perfect for specific applications requiring lower-profile solutions.



DIVERSITY IN DIVERTER VALVES

Our diverter valves are suitable for various applications, depending on your specifications. The plug-type diverter valves excel in versatility. The gravity plug-type diverter valves offer variety in the number of pipes and can handle quick product changes. The tube type diverter valves are USDA-approved for hygienic processes. The flap-type diverter valves offer efficient sealing while conveying various materials. Last – but not least – are the ball-type diverter valves, which excel in abrasive environments through easy maintenance.



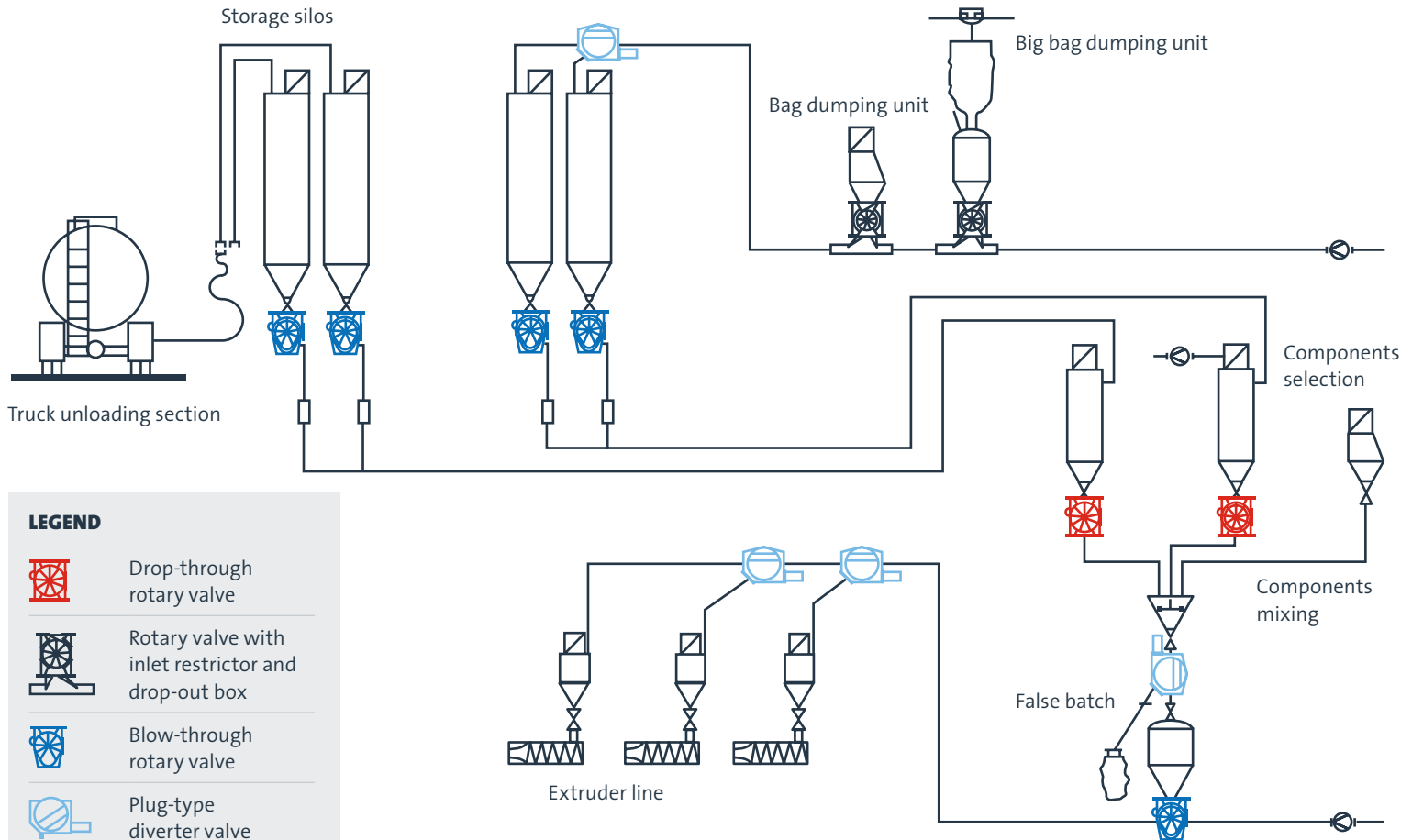

DMN-WESTINGHOUSE IN YOUR SYSTEM

The rotary valves and diverter valves from DMN-WESTINGHOUSE form the reliable foundation for safe and efficient dry bulk handling systems across a diverse range of industries. Depending on your requirements and system specifications, the properties of our products can be customised to achieve optimal results. This applies to functionality, and in terms of maintenance and cleaning.

DMN-WESTINGHOUSE offers rotary valves and diverter valves tailored for specific applications, such as processing abrasive pellets or sticky dairy ingredients. Additionally, our range includes rotary valves that serve as ideal replacements for discontinued brands like Niro. Whatever you are looking for, DMN-WESTINGHOUSE has a reliable solution.



LEGEND

-  Drop-through rotary valve
-  Rotary valve with inlet restrictor and drop-out box
-  Blow-through rotary valve
-  Plug-type diverter valve

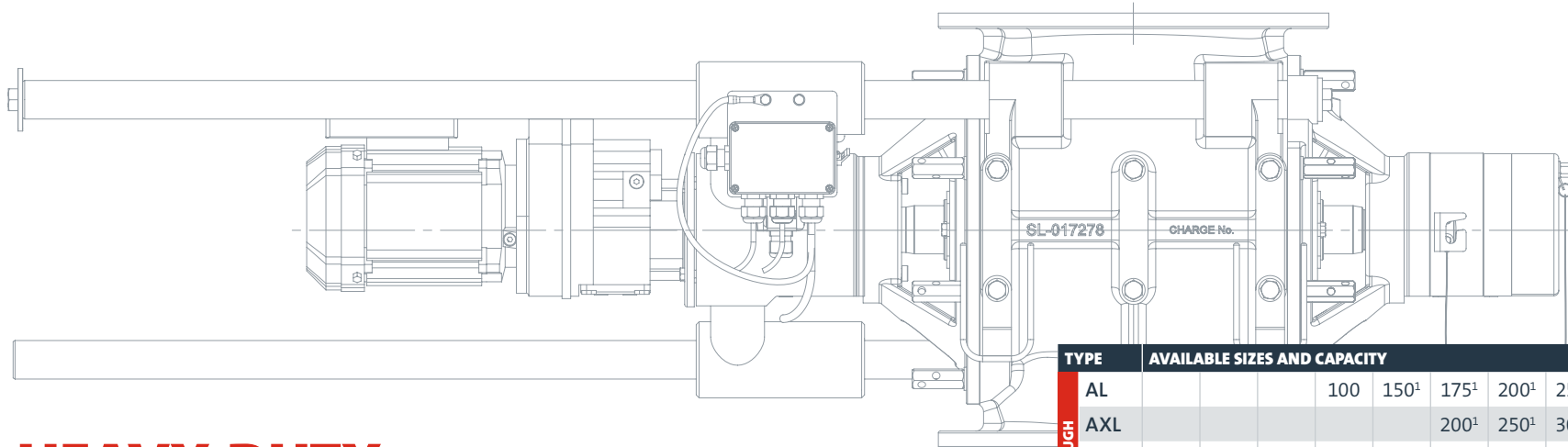

HEAVY-DUTY ROTARY VALVES

DMN-WESTINGHOUSE has developed heavy-duty rotary valves as custom solutions for a wide range of applications involving the metering and pneumatic conveying of products in powder and granular form. The heavy-duty rotary valves are available in a drop-through or blow-through variant and offer great capabilities, like minimum air leakage and high filling efficiency. The heavy-duty rotary valves

have outboard bearings and offer round or square connection flanges in three casting materials: stainless steel, cast iron, and aluminium, with a wide range of shaft seals and rotor models to select from. Available in various sizes (flange inlets 100-500), with a pressure rating of 2 barg and a standard temperature range[^] up to +150°C (optional up to +600°C).

[^]Size 400/450/500 reduced pressures according to PED.

TYPE		AVAILABLE SIZES AND CAPACITY												
DROP-THROUGH	AL				100	150 ¹	175 ¹	200 ¹	250 ¹	300 ¹	350 ¹	400	450	500
	AXL						200 ¹	250 ¹	300 ¹	350 ¹				
	AML				100	150 ¹	200 ¹	250 ¹	300 ¹	350 ¹	400 ¹			
	USAL						200	250	300					
	NR									347 ¹				
SAL	50	65	80	100	150									
BLOW-THROUGH	BL					150 ¹	175 ¹	200 ¹	250 ¹	300 ¹	350 ¹			
	BXL						200 ¹	250 ¹	300 ¹	350 ¹				
	BXXL									350 ¹				
Ltr./rev. [*]	0.07	0.13	0.25	0.8	2.5	5.5	10.5	19	34	58	91	135	230	

TYPE		AVAILABLE SIZES AND CAPACITY				
DROP-THROUGH	GL	150	200	250	300	350
Ltr./rev. [*]		5	10	17.5	32	79

^{*}At 100% filling.

¹ Versions for dairy processing and MZC, MZC-I, and MZC-II available.

Our heavy-duty rotary valves provide solutions to meet every industry standard and specific production needs. A few examples:

- We have designed a hygienic rotary valve that is USDA-accepted and EHEDG-certified. It can be opened from one or two sides for easy access and offers an optional slide to facilitate complete rotor extraction for cleaning.
- We have developed the RID 3.0, a detection unit to protect your process and products from metal contamination. As with any rotating parts, such contamination can occur for several reasons.
- We offer ATEX certification for equipment or protective systems (explosion barriers). This certification ensures the rotary valves comply with the necessary safety standards and regulations for explosive atmospheres.
- We offer various coatings and models for handling abrasive materials to enhance durability.
- We offer rotary valve types to minimise product degradation of granules, for example, in the plastics industry, to maintain product quality.

DROP-THROUGH



AL/AXL rotary valve



AML rotary valve



GL rotary valve



NR347 rotary valve



SAL rotary valve

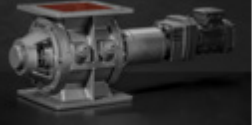

USAL rotary valve

BLOW-THROUGH



BL/BX/BXXL rotary valve

OPTIONAL SLIDE RAILS



MZC rotary valve



MZC-I rotary valve



MZC-II rotary valve

This model is also available with a chain drive and a direct drive without coupling.



AL/AXL ROTARY VALVE

The AL and AXL rotary valves, adept in metering and conveying powders and granules, feature modular designs for various configurations. With its larger inlet, the AXL excels in managing products with challenging flow properties. These stainless-steel rotary valves are ideal for the food and pharmaceutical sectors, which meet

USDA Dairy and EC1935/2004 standards, offering easy disassembly and high hygiene. MZC models simplify rotor and end cover removal by adding rails, while the adaptable AML variant transitions between round and square interfaces, enhancing versatility in system design.

SPECIFICATIONS

- Minimum air leakage.
- High filling efficiency.
- Sheared angle inlet.
- Large inlet size in relation to rotor volume.
- Customised solutions.
- Easily detachable versions available.
- Drilled flanges in accordance with PN10, ANSI 150lbs.
- Temperature up to +150°C.
- Pressure up to 2 barg.
- Temperature range customised models: -200°C to +600°C.
- EHEDG Type ED class II certification available.
- USDA Dairy-accepted.



- ATEX APS-certified versions withstand pressures up to 10 barg.
- EC1935/2004-compliant version available.
- ATEX 2014/34/EU certification available.
- ATEX Autonomous Protective System (APS) certification available.

The AXL size corresponds with the dimension of the inlet flange.

TYPE	AVAILABLE SIZES AND CAPACITY									
AL	100	150	175	200	250	300	350	400	450	500
AXL			200	250	300	350				
Ltr./rev.*	0.8	2.5	5.5	10.5	19	34	58	91	135	230

*At 100% filling.

This model is also available with a chain drive and a direct drive without coupling.



AML ROTARY VALVE

The AML rotary valves are suitable for many applications in the metering and pneumatic conveying of products in powder and granular form. These valves can also act as a transition piece from round to square and vice versa. The AML rotary valve range also

includes USDA Dairy-accepted models and versions compliant with the EC1935/2004 directive for sanitary use in the food and pharmaceutical industry. These stainless-steel rotary valves are easily detachable and meet the highest hygienic standards.



SPECIFICATIONS

- Minimum air leakage.
- High filling efficiency.
- Sheared angle inlet.
- Easily detachable versions available.
- Customised solutions.
- Large inlet size in relation to rotor volume.
- Drilled flanges in accordance with PN10, ANSI 150lbs.
- Body with one round and one square flange.
- Used as an adapter piece from round to square and from square to round.
- Temperature up to +150°C.
- Pressure up to 2 barg.
- Temperature range customised models: -200°C to +600°C .
- Pressure shock resistance customised models up to 10 barg.
- EC1935/2004-compliant version available.
- ATEX Autonomous Protective System (APS) certification available.
- ATEX 2014/34/EU certification available.

TYPE	AVAILABLE SIZES AND CAPACITY						
AML	100	150	200	250	300	350	400
Ltr./rev.*	0.8	2.5	5.5	10.5	19	34	58

*At 100% filling.

This model is also available with a chain drive and a direct drive without coupling.

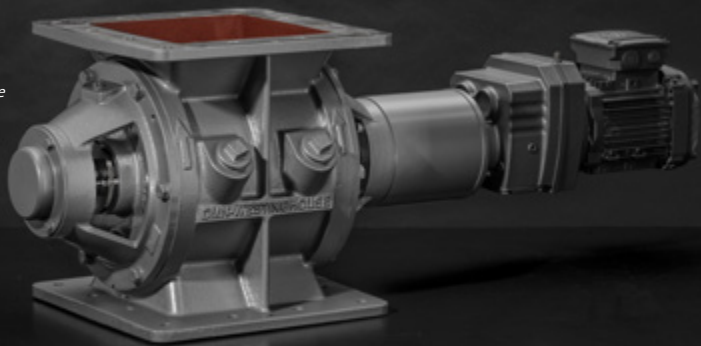

USAL ROTARY VALVE

The USAL rotary valves have been designed for many applications in the metering and pneumatic conveying of products in powder and granular form. The USAL has square inlet/outlet flanges. It has an enlarged inlet, designed for applications where inlet size is more important than capacity, or for handling products that flow poorly.

SPECIFICATIONS

- Minimum air leakage.
- High filling efficiency.
- Sheared angle inlet.
- Customised solutions.
- Easily detachable versions available.
- Full cast iron versions available.
- Temperature up to +150°C.
- Special configurations for temperatures up to +400°C available.
- Pressure up to 2 barg.
- EC1935/2004-compliant version available.
- ATEX 2014/34/EU certification available.

TYPE	AVAILABLE SIZES AND CAPACITY		
USAL	200	250	300
Ltr./rev.*	5.5	10.5	19

*At 100% filling.

This model is also available with a chain drive and a direct drive without coupling.



GL ROTARY VALVE

The GL rotary valves are specially designed for gravity feeding and pneumatically conveying of granular products. The configuration of the body and rotor has been developed specifically to minimise product degradation while retaining the best possible pocket-filling efficiency.

SPECIFICATIONS

- High filling efficiency.
- Maximum protection against product degradation.
- Large air vent opening.
- Available with direct drive or chain drive.
- Robust construction.
- Flanges drilled in accordance with PN10, ANSI 150 lbs.
- Temperature up to +150°C.
- Pressure up to 1.5 barg.
- ATEX 2014/34/EU certification available.

TYPE	AVAILABLE SIZES AND CAPACITY				
GL	150	200	250	300	350
Ltr./rev.*	5	10	17.5	32	79

*At 100% filling.

This model is also available with a chain drive and a direct drive without coupling.



NR347 REPLACEMENT ROTARY VALVE

Thinking of replacing your existing Niro rotary valves? Our NR (Niro Replacement) rotary valve matches the outer dimensions of the existing Niro rotary valve in your system, meaning they are an exact fit for most of the time. Our replacement rotary valves are based on the AL250 model, and made of stainless steel. They meet all hygiene and safety standards, ensuring their future-proof value.

SPECIFICATIONS

- Exact-fit rotary valve dimensions.
- Easy installation.
- Inlet round – outlet square.
- Versions with guide rails are available.
- USDA Dairy-accepted.
- Product surfaces are FDA-approved.
- EC1935/2004-compliant version available.
- ATEX 2014/34/EU certification available.

TYPE	AVAILABLE SIZES AND CAPACITY
NR347	347
Ltr./rev.*	19

*At 100% filling.



SAL SANITARY ROTARY VALVE

The SAL rotary valve is a low-capacity rotary valve with a highly polished surface inside and outside. The SAL is suitable for metering applications where very high hygienic standards, and ease of operation and cleaning are required. The complete rotary valve can be dismantled for inspection and cleaned in minutes, thus reducing eventual downtime and production loss.

SPECIFICATIONS

- For sanitary use.
- Low capacity.
- Easily detachable rotor.
- The complete valve is highly polished (inside and outside).
- Temperature up to +100°C.
- Pressure up to 1 barg.
- Product surfaces are FDA-approved.
- EC1935/2004-compliant version available.
- ATEX 2014/34/EU certification available.

TYPE	AVAILABLE SIZES AND CAPACITY				
SAL	50	65	80	100	150
Ltr./rev.*	0.07	0.13	5.5	0.8	2.5

*At 100% filling.

This model is also available with a chain drive and a direct drive without coupling.



BL/BXL/BXXL ROTARY VALVE

Engineered for precision in metering and pneumatic conveying, our BL, BXL, and BXXL rotary valves easily handle powder and granular products. Their modular design allows for diverse configurations. The BXL rotary valve, with its enlarged inlet, excels in applications demanding larger inlets or processing products that do not flow smoothly, with the BXXL offering

an even greater inlet size. Crafted from cast iron, stainless steel, or aluminium, these rotary valves are quickly detachable, maintaining the highest hygienic standards. The BL, BXL and BXXL models also come in MZC versions, featuring supportive rails for effortless end cover and rotor removal without damaging the housing.

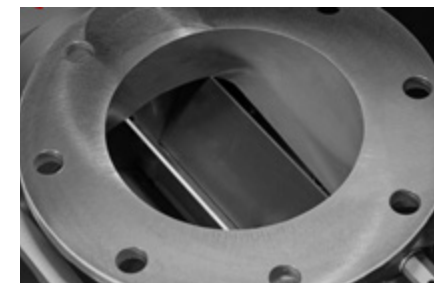
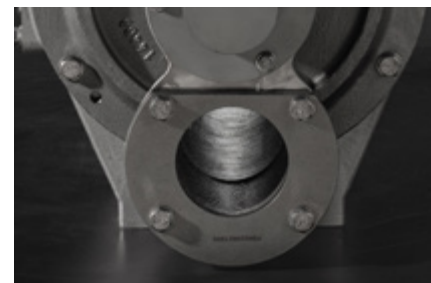

SPECIFICATIONS

- Minimum air leakage.
- High filling efficiency.
- Sheared angle inlet.
- Easily detachable versions available.
- Drilled flanges in accordance with PN10, ANSI 150lbs.
- Temperature up to +150°C.
- Pressure up to 2 barg.
- EHEDG Type ED class II certification available.
- USDA Dairy-accepted.
- ATEX 2014/34/EU certification available.
- ATEX Autonomous Protective System (APS) certification available.
- Customised solutions.

The BXL and BXXL size corresponds with the dimension of the inlet flange.

TYPE	AVAILABLE SIZES AND CAPACITY					
BL	150	175	200	250	300	350
BXL		200	250	300	350	
BXXL				350		
Ltr./rev.*	2.5	5.5	10.5	19	34	58

*At 100% filling.

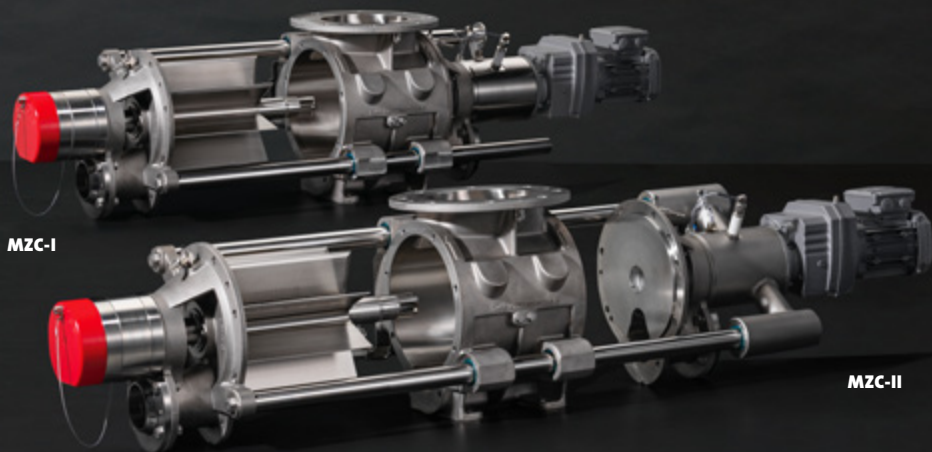

MZC-I AND MZC-II ROTARY VALVES WITH SLIDE RAILS

Meet the MZC-I and MZC-II, our top-level range of rotary valves that sets the standard in the field of safety, hygiene, and cleanability. Today and in the future. Extreme durability and efficiency, combined with ease of cleaning, make the MZC-I and MZC-II the reliable core of your production processes. Maximise your output while

cutting time and costs for maintenance and thorough cleaning.

MZC-I The all-purpose rotary valve with a compact design.

MZC-II The ultimate rotary valve that meets the highest hygiene requirements.

THE MZC-I AND MZC-II ROTARY VALVES OFFER YOU

- Unprecedented cleanability.
- Easier and safer maintenance than before.
- Applications for a broad range of industries.
- Cleaning In Place (CIP): the rotor can remain in position during cleaning.
- Additional safety through an integrated emergency safety switch.

Which rotary valve you choose depends on your requirements for hygiene and access to the rotary valve.



MZC-II CHARACTERISTICS

- Opens on two sides for unprecedented ease of access and superior cleanability.
- Only a direct drive is offered, to allow for ease of opening and cleaning.

MZC-I CHARACTERISTICS

- Space-efficient one-sided opening.
- Various drive options.

TYPE		AVAILABLE SIZES AND CAPACITY					
DROP THROUGH	AL	150	175	200	250	300	350
	AXL		200	250	300	350	
	AML	150	200	250	300	350	400
	NR				347		
BLOW THROUGH	BL	150	175	200	250	300	350
	BXL		200	250	300	350	
	BXXL				350		
Ltr./rev.*		2.5	5.5	10.5	19	34	58

*At 100% filling.

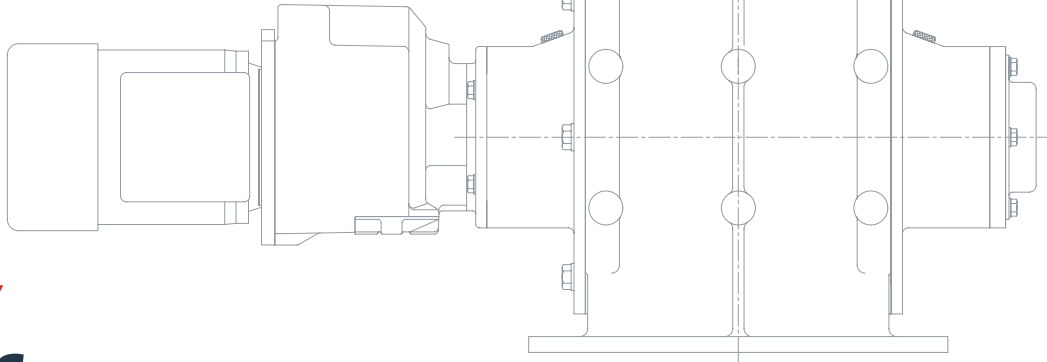

MEDIUM-DUTY ROTARY VALVES

DMN-WESTINGHOUSE has developed a specialised product line of medium-duty rotary valves to address customer needs in scenarios where rotary valves with outboard bearings (heavy-duty rotary valves) might be considered excessive. A simple construction and direct drive contribute to providing exceptional value for money.

Medium-duty rotary valves feature inboard bearings and are available in a drop-through design, providing a select range of shaft

seals and rotor configurations. They come in various sizes with flange inlets ranging from 100 to 400 mm, can handle a pressure differential of up to 1 barg, and operate within a standard temperature range of up to +65°C.

For applications in potentially explosive environments, the medium-duty rotary valves come with ATEX certification. This certification ensures the rotary valves comply with the necessary safety standards and regulations for explosive atmospheres.

TYPE		AVAILABLE SIZES AND CAPACITY						
DROP-THROUGH	MLD	100	150	200	250	300	350	400
	MALD	100	150	175	200	250	300	350
Ltr./rev.*		0.8	2.5	5.5	10.5	19	34	58

*At 100% filling.



TYPE		SIZES AND CAPACITY		
DUST VALVE	DL	200	250	300
	Ltr./rev.*	6	8.5	19

*At 100% filling.

DROP-THROUGH



MALD rotary valve



MLD rotary valve

DUST VALVE



DL rotary valve



MLD

MALD



MLD/MALD ROTARY VALVE

The MALD and MLD medium-duty rotary valves offer exceptional value and versatility for various applications. Ideal for vacuum conveying, big bag unloading, cyclone applications, and general purposes, both rotary valves are distinguished by their simple construction and direct drive. Using the AL rotary valve body with two

round flanges, the MALD rotary valve is optimal for powder handling. In contrast, the MLD rotary valve features an ML rotary valve body with larger round and square flanges, enhancing its efficiency with free-flowing products and facilitating transitions between different connections.

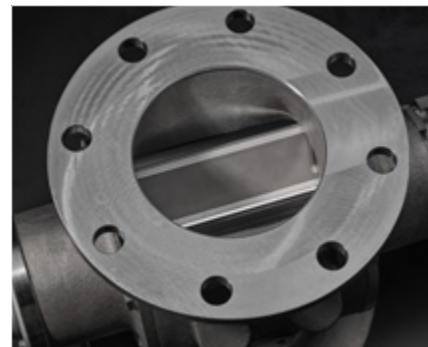

SPECIFICATIONS

- Compact design.
- Sheared angle inlet/outlet.
- Suitable for frequency inverter control.
- Standard fitted with direct drive.
- Round flange drilling available for PN10 and ANSI 150 lbs.
- The MLD is used as an adapter piece from round to square and from square to round.
- Temperature up to +65°C.
- Pressure up to 1 barg.
- Pressure shock resistant up to 10 barg.
- EC1935/2004-compliant version available.
- ATEX 2014/34/EU certification available.

TYPE	AVAILABLE SIZES AND CAPACITY						
MLD	100	150	200	250	300	350	400
MALD	100	150	175	200	250	300	350
Ltr./rev.*	0.8	2.5	5.5	10.5	19	34	58

*At 100% filling.

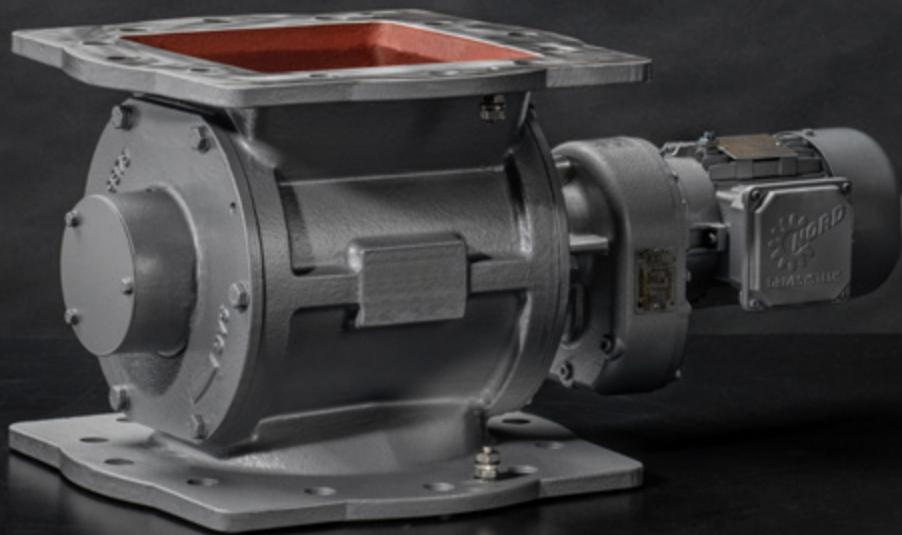

DL ROTARY VALVE

The DL dust lock is a rotary valve with a dedicated design for filter applications. It can be used with dust filters, cyclones, product separators, and dosing systems. The universal flanges on both sides of the

rotary valve are used for round or square connections. This application is much more sensitive to dust explosions; therefore, we have ATEX-certified this valve for equipment or protective systems (explosion barriers).

SPECIFICATIONS

- Minimum air leakage.
- Suitable for both round and square counter flanges.
- Rotors available with adjustable polyurethane or fixed chamfered mild steel blades.
- Ex-stock delivery for standard models.
- Flameproof versions available.
- Temperature up to +70°C.
- Pressure up to 0.5 barg.
- ATEX Autonomous Protective System (APS) certification available.
- ATEX 2014/34/EU certification available.



TYPE	AVAILABLE SIZES AND CAPACITY		
DL	200	250	300
Ltr./rev.*	6	8.5	19

*At 100% filling.

ROTARY VALVE OPTIONS

ROTOR CONFIGURATIONS

At DMN-WESTINGHOUSE, we have a rotor for every application. With specific rotors, we can effectively tune every rotary valve to optimal performance for your specific application, from ultimate hygiene to resisting abrasive materials.

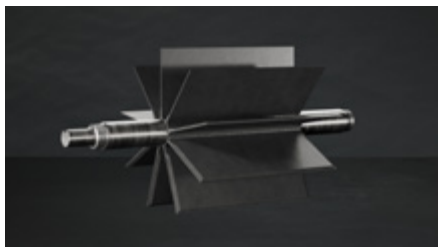

FIXED VANES

- All-purpose component.
- Chamfered vanes to reduce surface friction.
- Suitable for hygienic applications.
- Radius pockets to help discharge sticky/hygroscopic products.

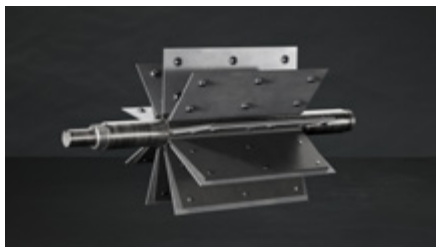

REPLACEABLE AND ADJUSTABLE BLADES

- Choose blade materials based on application requirements: steel, hardened steel for abrasive materials, stainless steel for corrosion resistance and sterility, polyurethane for non-friable granular products, and scraper blades for products that compress and build up on the surfaces, to minimise torque loads.
- Blades can be easily replaced to maintain tight clearances, rather than replace the complete rotor.
- Support bars can be used to reinforce the rotor when handling hard building products such as lactose and PVC powder.



RESILIENT EDGE

- Designed to handle heavy-duty applications.
- Reinforced vane edges, which protect the end covers.
- Distributes friction evenly across the entire end cover surface.
- The protective end plates and vane edges can easily be repaired.



SEMI END DISC WITH REPLACEABLE AND ADJUSTABLE BLADES

- Used for handling abrasive materials.
- Offers additional wear protection.
- Standard for 4TS model.
- Blades can be easily replaced to maintain tight clearances rather than replace the complete rotor.



END DISC FIXED VANES

- Commonly used when handling pelletised products, such as plastic pellets.
- Protects against end cover wear.

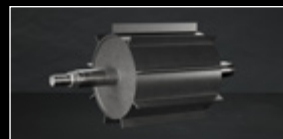

REDUCED CAPACITY CLOSED END

- When products have very poor flow characteristics, requiring an abnormally large inlet throat.
- Fixed vanes or adjustable blades.



SCALLOPED POCKETS

- Smooth rotor pockets are used to help discharge sticky/hygroscopic products.



FINE DOSING

- Used on metering applications when a specified throughput is required with a good level of accuracy.

COATING OPTIONS

Coatings play a crucial role in extending the lifespan of rotary valves and maintaining their performance in challenging processes, like the handling of minerals, where corrosion and abrasion are concerns. Choosing the right coating depends on the specific requirements of the process and the level of protection needed. Coatings can be applied to protect rotary valve parts such as the body, end covers, and rotors.

HARD CHROME COATING (PLATING)

Hard chrome coating (plating) as a cost-effective substitute for stainless steel. Hard chrome coating can be used for budget-friendly food applications or mild abrasive conditions.

NICKEL COATING

Nickel coating as an alternative to stainless steel for non-food applications (not for MZC rotary valve).

TUNGSTEN COATING

Tungsten coating can be used for moderate to highly abrasive products.

HARD ANODISING

Hard anodising the aluminium parts of rotary valves provides improved wear resistance.

DRIVE OPTIONS

DRIVE CONFIGURATIONS

We offer three types of drive configurations for our rotary valves. Each drive type is suited to fit specific system setups.



CHAIN DRIVE

- Compact, takes less space.
- By changing the chain wheel ratio, you can change rotor speed to get the correct throughput.
- Safety overload protection: the chain will break.
- Requires regular maintenance.
- Less hygienic.
- Not for ATEX zone 1-21.
- Not for RID.
- Not for medium-duty.



DIRECT DRIVE WITH COUPLING

- Rotor speed can be changed with the help of a frequency inverter/VFD.
- Minimum maintenance.
- Mandatory for MZC-II.
- Mandatory for RID option.
- Recommended for hygienic installation
- Not for medium-duty.



DIRECT DRIVE WITHOUT COUPLING

- Compact design (length).
- Recommended for hygienic installation.
- Rotor speed can be changed with the help of a frequency inverter/VFD.
- Minimum maintenance.
- Drive is directly connected to the rotary valve.
- Not for RID.
- Not for medium-duty.

ROTARY VALVE SOLUTIONS

Our R&D engineering team constantly develops innovative solutions that simplify our customers' work. The team's activities result in concrete product innovations and solutions that solve problems on a process level, like preventing product contamination or extending service life.

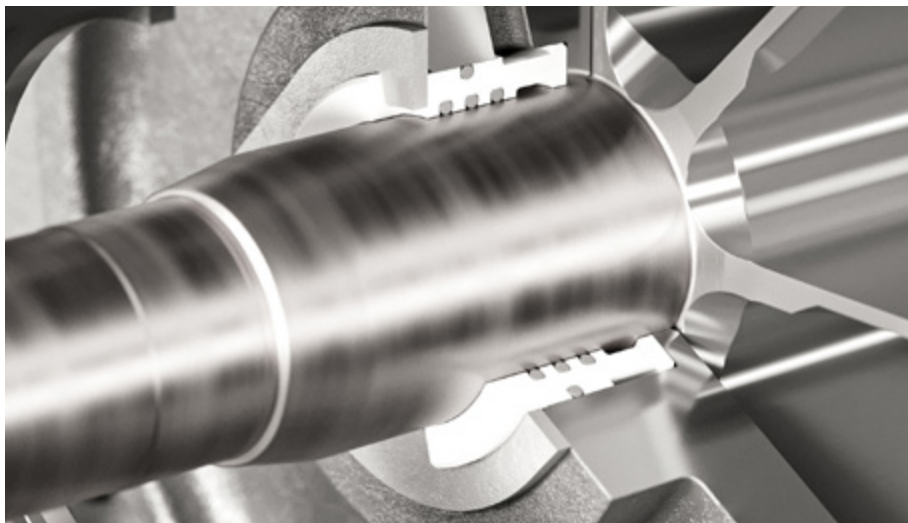

SAS-II ROTARY VALVE HEAVY-DUTY SHAFT SEAL

Process engineers in today's food and pharmaceutical sectors require dependable, easy-to-maintain equipment that meets top safety standards. At DMN-WESTINGHOUSE, we've innovated the SAS-II air purge shaft seal, designed to eliminate leakage issues reliably.

Building on the proven success of our original SAS shaft seal, the SAS-II is more compact and prevents overtightening. Choose SAS-II for assured performance and ultimate peace of mind in your operations.

ROTOR INTERFERENCE DETECTION RID 3.0

The Rotor Interference Detection system (RID) detects unwanted contact between the rotor, body, or end covers and warns the operators of possible contamination of the conveyed product. Incorporate the RID into your system for alerts on product accumulation or metal contact. Next to its analogue outputs, the third-generation RID offers EtherNet/IP™ or 4-20mA output communication, enhancing your network's automation capabilities.

DMN-WESTINGHOUSE rotary valves are produced to the strictest tolerances, and rotor movement is not likely to occur. However, movement can occur if the rotor becomes damaged by foreign objects passing through the rotary valve. In that case, the rigid and straightforward design of the RID ensures problem-free operation. It features a user-friendly service tool for maintenance and troubleshooting. CE and CSA certification confirm compliance with international safety and performance standards.





SHAFT SEAL FLOW CONTROL

Discover our solution that boosts the reliability of AL and BL heavy-duty rotary valve series (including AXL, BXL, BXXL and NR) even more: the DMN-WESTINGHOUSE Shaft seal flow control. This flow control system ensures a consistent and controlled airflow, even in the face of pressure variations, to protect the shaft seals and prevent wear, ultimately contributing to the reliability and performance of

your equipment. Unlike pressure, airflow can be monitored precisely to register blockages or leaks.

Flow control is the go-to solution for CIP processes. On top of that, accurate flow control prevents the build-up of powder residue on the shaft seals that could lead to seal failure, causing contamination, leakage, damage, and downtime for cleaning and repair.

ROTARY VALVE ACCESSORIES

The rotary valves and diverter valves of DMN-WESTINGHOUSE can be upgraded with accessories that enhance their functionality or adapt their properties to suit specific conveying processes.

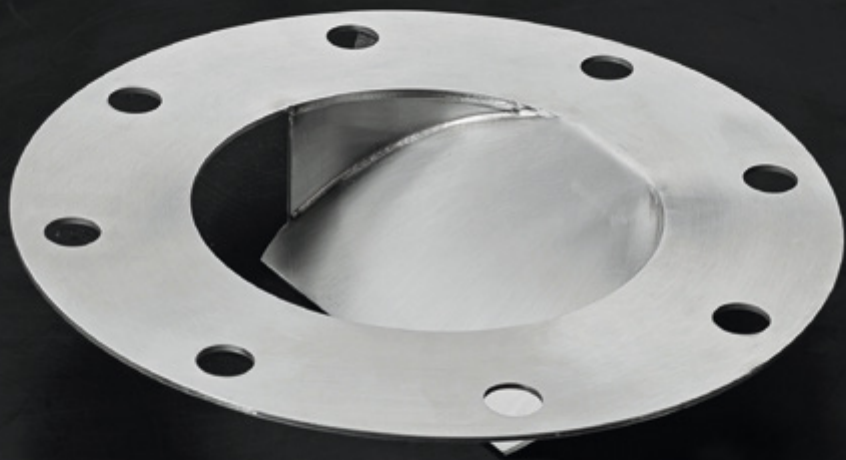

INLET RESTRICTOR

When controlled material flow is required, the inlet restrictor prevents shearing and keeps material away from the rotor tips, minimising the risk of jamming.

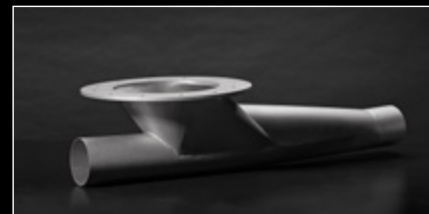

DROP-OUT BOX

The adapter is designed to connect the discharge of the rotary valve to a pneumatic or vacuum conveying line. This is particularly useful when handling abrasive products, as it allows for easier cleaning of the rotary valve without the need to remove the piping.



VENT BOX

The vent box is used to collect and vent the pressurised air within the rotor pockets and vent any air leakage over the rotary valve, to improve the filling efficiency of the rotary valve. It ensures smooth material flow and contributes to the overall effectiveness and of the pneumatic conveying system.

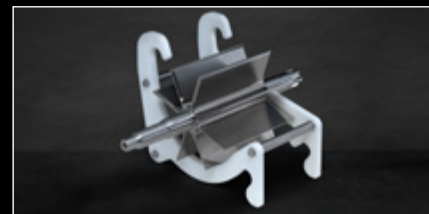

CRADLE FOR MZC-I & MZC-II

Your rotor can be taken out as a whole (finger-safe rotor extraction) and placed in this cradle for precision cleaning.



BEARING TOOLKIT

Worn-out bearings can cause severe damage to your rotary valves. The toolkit allows you to properly replace the bearings of your rotary valve for a perfectly functioning product.

DIVERTER VALVES

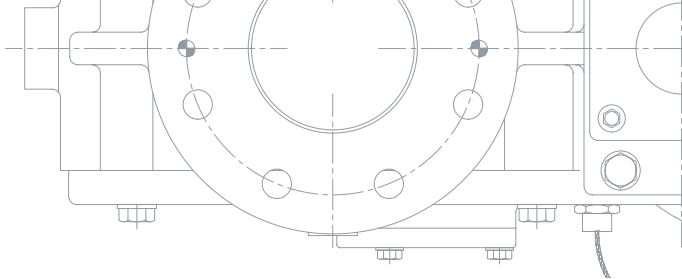

DMN-WESTINGHOUSE has developed diverter valves for rapid pipe changeover between powders and pellets in pneumatic conveying systems. Diverter valves are categorised into various types based on operating principles and design, such as

plug, tube, flap, or ball types, each suited for pipe changeover tasks. The selection of a diverter valve type typically hinges on the application's specific requirements and the characteristics of the materials being conveyed.

TYPE		AVAILABLE SIZES									
PLUG	PTD-II	50	65	80	100	125	150	200			
	SPTD	150	162	200	213	250	267	300	318	350	400
	SPTDS	50	65	80	100	125					
	GPD	150 ¹	200 ¹	250 ¹	300 ¹						

TYPE		AVAILABLE SIZES						
TUBE	2-TDV/3-TDV	40 ¹	50 ¹	65 ¹	80 ¹	100 ¹	125 ¹	150 ¹
	M-TDV	40 ¹	50 ¹	65 ¹	80 ¹	100 ¹	125 ¹	150 ¹
Ports (M-TDV only)		4 up to 14	4 up to 13	4 up to 12	4 up to 11	4 up to 10	4 up to 8	4 up to 7

TYPE		AVAILABLE SIZES							
FLAP	FDV-F	50	65	80	100	125	150	200	250
	FDV-P	50	65	80	100	125	150		

TYPE		AVAILABLE SIZES						
BALL	BTD	65	80	100	125	150	200	250

¹ Versions for dairy processing available.

PLUG TYPE



PTD-II diverter valve



SPTD diverter valve



SPTDS diverter valve



GPD diverter valve

TUBE TYPE



2-TDV diverter valve



3-TDV diverter valve



M-TDV diverter valve

BALL TYPE



BTD diverter valve

FLAP TYPE



FDV-F/FDV-P diverter valve



PTD-II DIVERTER VALVE

The PTD-II plug-type diverter valves have been specially designed to route powders and pellets with minimum degradation in pneumatic conveying systems. Precision machining, proper sealing, and an obstruction-free internal geometry guarantee a smooth passage of the product.

The user-friendly, foolproof design enables quick on-site, in-depth inspection, cleaning and, when necessary, replacement of seals. The PTD-II design complies with all current legislation regarding safety in the workplace. As such, the exterior of this diverter valve is free of moving parts.



SPECIFICATIONS

- Two-channel design.
- Minimal maintenance.
- Compact form.
- Versions with electrical drive available.
- Wear-resistant pipes optional.
- Temperature range: -25°C to +80°C at ambient temperatures of -10°C to +40°C.
- Pressure up to 3 barg with static seals.
- Sizes 50-150 up to 6 barg with inflatable seals.
- Pressure shock-resistant up to 10 barg*.
- EC1935/2004-compliant version available.
- ATEX 2014/34/EU certification available.

*Size 200 excluded.

TYPE	AVAILABLE SIZES						
PTD-II	50	65	80	100	125	150	200

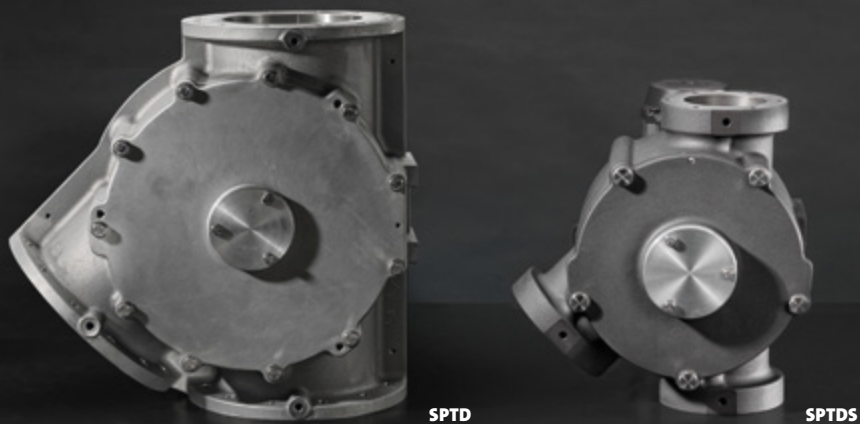

SPTD

SPTDS



SPTD/SPTDS DIVERTER VALVE

The SPTD and SPTDS single pipe plug diverter valve is specially designed to route powders and pellets with minimum degradation in pneumatic conveying systems. Precision machining, proper sealing, and an obstruction-free internal geometry guarantee a smooth passage of the product. The user-friendly, foolproof

design enables quick on-site internal examination, cleaning and, when necessary, replacement of seals. The design of the SPTD and SPTDS plug diverter valves complies with all current workplace safety legislations. As such, the exterior of this diverter valve is free of moving parts.

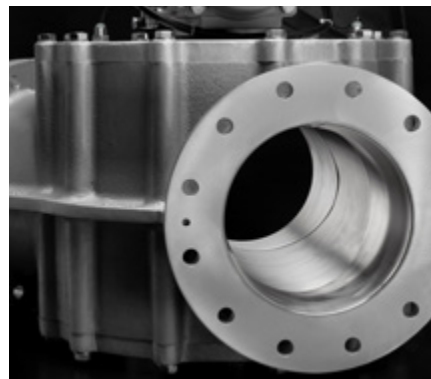

SPECIFICATIONS

- For diverting only.
- Universal application.
- No moving parts on the outside.
- Various options available.
- Static or inflatable seals (SPTD), static seals (SPTDS).
- Temperature up to +80°C at ambient temperatures between -10°C and +40°C.
- SPTD: pressure up to 3 barg static seal and pressure up to 6 barg inflatable seal.
- SPTDS: pressure up to 1 barg static seal.
- Pressure shock resistant up to 10 barg.
- EC1935/2004-compliant version available.
- ATEX 2014/34/EU certification available.

TYPE	AVAILABLE SIZES									
SPTD	150	162	200	213	250	267	300	318	350	400
SPTDS	50	65	80	100	125					



GPD DIVERTER VALVE

The GPD, a two-way gravity diverter valve, is perfect for systems needing regular, quick cleaning with minimal downtime. Its design ensures swift disassembly and easy access to all contact surfaces, even when installed. It offers unrestricted material flow, free of ledges or dead spots. Available in various

finishes, including sanitary specifications, the GPD also features USDA Dairy-accepted models. It efficiently diverts gravity-fed material to two lines, using a plug that rotates 120°, sealing the inactive port with precision-engineered tolerances.

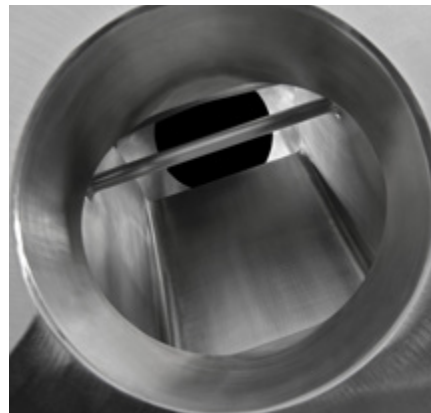

SPECIFICATIONS

- Rugged cast construction.
- Change on the fly with most powders.
- Easily detachable design.
- No pressure difference allowed.
- One-piece body with removable end plates and rotating blade assembly.
- Pneumatic or manual operation.
- Flanges drilled according to PN10 or ANSI 150 lbs.
- Available in stainless steel AISI 316, cast iron, and aluminium.
- Temperature range: -10°C to +80°C.
- USDA Dairy-accepted version available.
- EC1935/2004-compliant version available.
- ATEX 2014/34/EU certification available.

TYPE	AVAILABLE SIZES			
GPD	150	200	250	300



2-TDV/3-TDV DIVERTER VALVE

The 2-TDV is a compact diverter valve for pneumatically conveyed powders or pellets. It facilitates material transport to/from two locations. Engineered for precision, the 3-TDV diverter valve expertly handles the pneumatic conveyance of powder or pellet materials to/from three destinations. Its compact design incorporates an extra line cylinder, ensuring accuracy in tube positioning.

They both ensure precise tube positioning and offer easy disassembly for out-of-place

cleaning (COP). Alternatively, in-place cleaning (CIP) is achievable through line purging with cleaning liquid, without diverter valve removal. Complete removal is necessary only for thorough cleaning. This flexibility allows the customisation of cleaning methods to fit specific processes. Versions meeting stringent hygienic standards, including USDA Dairy acceptance, are available for specialised applications.



SPECIFICATIONS

- Converging and diverging applications.
- Multiple choice of line connections.
- Minimised product degradation.
- A uniform, smooth bore pipe between the inlet and outlet.
- Inflatable seals.
- Easy detachable construction.
- All stainless steel or aluminium/stainless steel configurations.
- Temperature range: -20°C to + 100°C.
- Pressure range: -0.8 to 3 barg.
- USDA Dairy-accepted versions available.
- EC1935/2004-compliant version available.
- ATEX 2014/34/EU certification available.

TYPE	AVAILABLE SIZES						
2-TDV/3-TDV	40	50	65	80	100	125	150

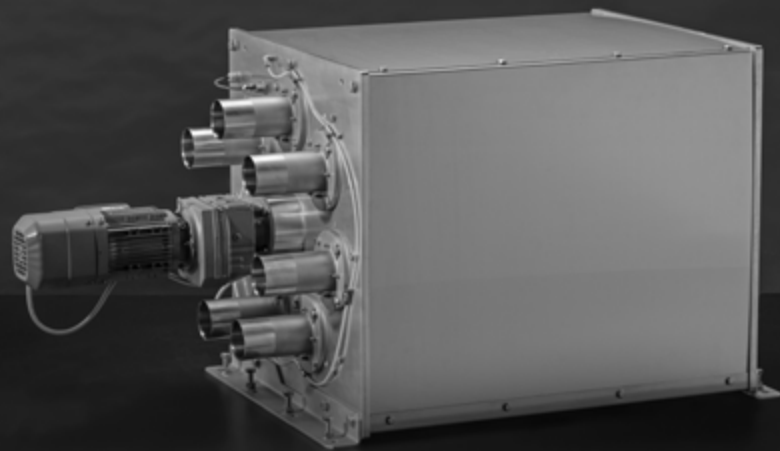

M-TDV DIVERTER VALVE

The M-TDV efficiently handles the pneumatic transport of powders or pellets, facilitating diverging and converging flows to multiple destinations. Its design ensures high positional accuracy with minimal components. Available in sizes from 40 to 150 mm, it offers up to 14 ports on larger

models for smaller pipe sizes. The standard setup includes the diverter valve unit and a pre-programmed controller with an integrated PLC compatible with binary code input from the customer's PLC. The range also features USDA Dairy-accepted models.

SPECIFICATIONS

- Converging and diverging applications.
- Up to 14 ports.
- Compact design.
- Minimised product degradation.
- A uniform, smooth bore pipe between the inlet and outlet.
- Inflatable seals.
- All product contact materials FDA-approved.
- Temperature range: -20°C to +100°C.
- Pressure range: -0.8 to 3 barg.
- USDA Dairy-accepted versions available.
- EC1935/2004-compliant version available.
- ATEX 2014/34/EU certification available.

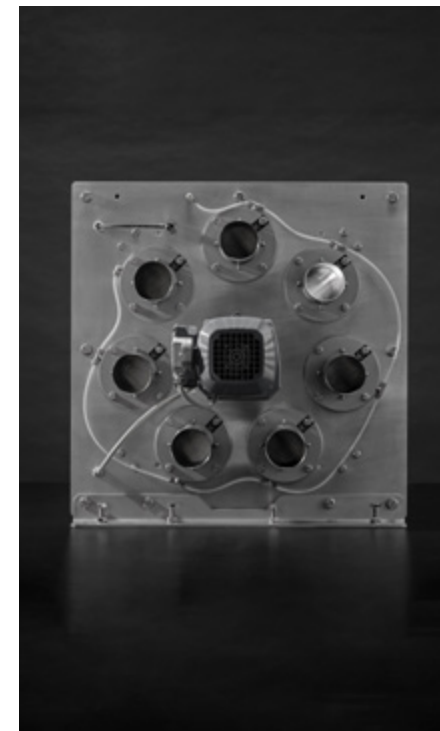

TYPE	AVAILABLE SIZES						
M-TDV	40	50	65	80	100	125	150
Number of ports	4 up to 14	4 up to 13	4 up to 12	4 up to 11	4 up to 10	4 up to 8	4 up to 7

FDV-P

FDV-F

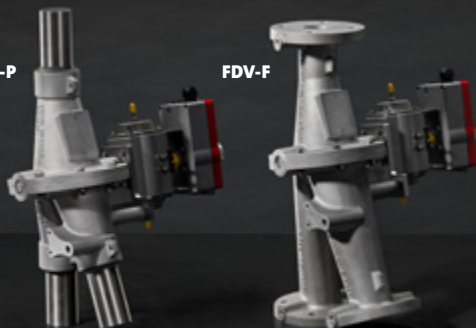

FDV-P/FDV-F DIVERTER VALVE

The FDV flap-type diverter valves are designed to divert powders and pellets in pneumatic conveying systems. The FDV is available in two versions: the FDV-F type with flange ends and the FDV-P type with pipe ends. Both versions are available in aluminium, cast iron, and stainless steel. The FDV has three operating modes: a pneumatic actuator, an electrical actuator, and manual operation.

SPECIFICATIONS

- Compact form, simple construction, optimal sealing.
- Minimal pressure loss.
- Available with flange or pipe fittings.
- Flanges drilled in accordance with PN10, ANSI 150 lbs.
- Cast iron, aluminium, or 316 stainless steel.
- Temperature range: -10°C to +80°C.
- Pressure range: -0.3 barg up to 2 barg.
- EC1935/2004-compliant version available.
- ATEX 2014/34/EU certification available.

TYPE	AVAILABLE SIZES							
FDV-F	50	65	80	100	125	150	200	250
FDV-P	50	65	80	100	125	150		



BTD DIVERTER VALVE

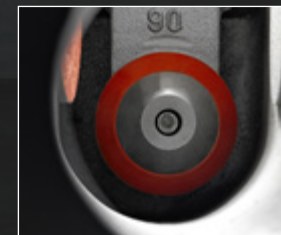

The BTD ball-type diverter valve, adept at handling abrasive products, is well-suited for high-pressure and high-temperature settings, commonly found in thermoelectric power plants (handling coal and fuel oil ash), incinerators, foundries, and cement, glass, chemical, and other industries. Versatile in function, it facilitates both diverging and converging of materials. In diverging applications, the product itself acts as the wear surface. For converging, its impact area is significantly reinforced. Constructed from robust ductile spheroidal cast iron, the BTD is designed for durability and efficiency.

SPECIFICATIONS

- Designed to handle abrasive products.
- Suitable for systems with high pressures and temperatures.
- Replaceable wear bushings on the outlet.
- Grease-lubricated shaft seals.
- Seals replaceable with the valve in place.
- Body made from ductile spheroidal cast iron.
- Temperature range: -10°C to +80°C.
- Pressure range: -0.5 to 6 barg.
- Higher temperature-resistant versions can be manufactured upon request.
- ATEX 2014/34/EU certification available.

TYPE	AVAILABLE SIZES							
BTD	65	80	100	125	150	200	250	

COMPONENTS



PRESSURE RELIEF VALVE (PRV)

The DMN-WESTINGHOUSE pressure relief valve is a crucial safety device that prevents vessels like hoppers or silos from exploding (due to overpressure) or imploding (due to excessive vacuum). It maintains atmospheric pressure by releasing excess pressure or allowing air in to equalise vacuum conditions. This automatic valve is adjustable, ensuring safety and protecting personnel and equipment. It is constructed for outdoor conditions.



COMPRESSION COUPLINGS

The original Morris compression coupling is designed to join pipe and tubing for pneumatic conveying systems. Couplings are made of heavy-gauge zinc-plated steel. The gaskets are available in white neoprene and a variety of other materials and are easy to install.



DISCHARGE UNIT (DUC)

The DMN-WESTINGHOUSE discharge unit is designed to prevent product bridging at the hopper outlet (up to 5 m³). A rotating paddle inside the hopper cone keeps the product in motion. This design is particularly beneficial when dealing with mixed products, as the rotating blade helps to avoid product separation at the hopper outlet. The discharge unit guarantees a

smooth product flow and maximises the filling efficiency of the component installed below the unit (e.g. a rotary valve).

All product contact surfaces are manufactured from stainless steel, and the discharge unit has specially designed seals to withstand internal pressures up to 1 barg at +100°C.



CONTACT

WORLDWIDE DISTRIBUTION NETWORK

We are a global company with sales offices and distributors around the world. With our knowledge and expertise, we provide custom-made solutions and support to meet the unique needs of each customer. For more information and other inquiries, please contact your local sales team or distributor. You can find a complete list of distributors at dmnwestinghouse.com/distributors.

THE NETHERLANDS

DMN-WESTINGHOUSE

Gieterij 3
2211 WC Noordwijkerhout
+31 252 361 800
sales@dmnwestinghouse.com

GERMANY

DMN SGT GMBH

Lanzstraße 1
D-21244 Buchholz in der Nordheide
+49 4181 931 40
dmn.sgt@dmnwestinghouse.com

FRANCE

DMN FRANCE SAS

Abbaye Royale de Yerres
20, Rue Raymond Poincaré
F-91330 Yerres
+33 1 69 49 85 70
contact.fr@dmnwestinghouse.com

USA

DMN INC.

220 South Woods St.
West Memphis, AR 72301
+1 870 733 9100
sales.us@dmnwestinghouse.com

UNITED KINGDOM

DMN UK LTD

Units 1 & 2, 9 Harris Road
Porte Marsh Industrial Estate
Calne, Wiltshire, SN11 9pt, UK
+44 1249 818 400
dmn.uk@dmnwestinghouse.com

INDIA

DMN INDIA PRIVATE LIMITED

2nd floor, no. 28 Gnt Road | SF No. 58/2a
Thandalkalani, Puzhal, Tiruvallur
Chennai – 600066, Tamil Nadu
+91 9940482573
india@dmnwestinghouse.com



Nothing of this publication may be copied or reproduced in any other form.
Printing errors and changes reserved. ©2024 DMN-WESTINGHOUSE.

A technical drawing of a circular component, possibly a flange or a cover, rendered in white lines on a black background. The drawing shows a large central circle with a smaller concentric circle inside. The outer circle has 12 small circles around its perimeter, each with a crosshair. The component is surrounded by various mechanical details, including bolts, nuts, and mounting brackets. In the center of the large circle, the logo 'DMN WESTINGHOUSE' is displayed. 'DMN' is in a stylized font, with 'D' in white and 'MN' in red. 'WESTINGHOUSE' is in white, all-caps, sans-serif font.

DMN
WESTINGHOUSE

DMNWESTINGHOUSE.COM